

SPECIALTY ADAPTERS

Specialty Adapters

• **Vertical to Horizontal Adapter** 4.7 lbs.

KIT NUMBER	DESCRIPTION
AK-071-10	ASTM A108-1215 CS w/CS Bolts
AK-071-C0	ASTM A479-316 SS w/CS Bolts
AK-071-C0-W9	ASTM A479-316 SS w/316 SS Bolts

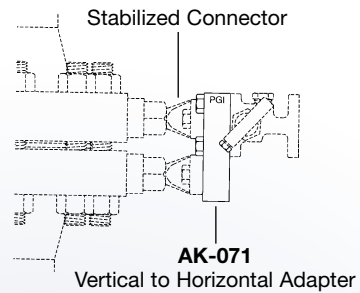
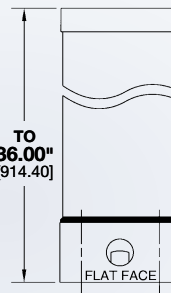

Chart Recorder Adapter with 2" Pipe Stand
(XX=Pipe Stand Length in Inches; 36" Max)

PART NUMBER	MATERIAL
AK-043-10-LXX	AISI 1018 CS
AK-043-C0-LXX	ASTM A479-316 SS



• **Spacer Adapters with 1/2" Auxiliary Taps** 1.01 lbs.

PART NUMBER	MATERIAL
AK-038-10	AISI 1018 CS w/CS Bolts
AK-038-C0	ASTM A479-316 SS w/CS Bolts
AK-038-C0-W9	ASTM A479-316 SS w/316 SS Bolts

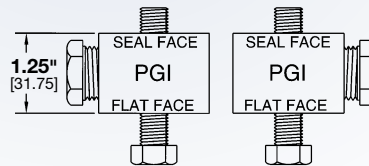

Orifice Filler Kits

PART NUMBER	DESCRIPTION
AK-044-R0	Teflon® Filler Kit
AK-045-R0	Teflon® Filler Kit & 23/64th Drill

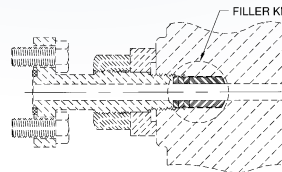

• **90° Twist Adapter - Rotates System 90°** 10.5 lbs.

PART NUMBER	MATERIAL
AK-053-10	ASTM A108-1215 CS w/CS Bolts
AK-053-C0	ASTM A479-316 SS w/CS Bolts
AK-053-C0-W9	ASTM A479-316 SS w/316 SS Bolts

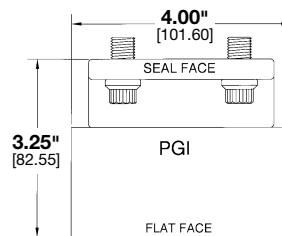

• **180° Twist Adapter - Rotates System 180°** 11 lbs.

PART NUMBER	MATERIAL
AK-068-10	ASTM A108-1215 CS w/CS Bolts
AK-068-C0	ASTM A479-316 SS w/CS Bolts
AK-068-C0-W9	ASTM A479-316 SS w/316 SS Bolts

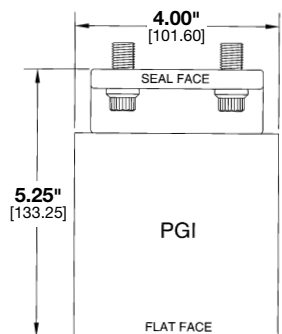

• **NOTE:** Teflon® Flange Seals Standard.
Add "MH" for Viton® O-Ring Seals.

SPECIALTY ADAPTERS

Specialty Adapters (continued)

• **Co-Equal**
ΔP to ΔP Adapter Plate (Parallel) 10 lbs.

PART NUMBER	MATERIAL (316 SS Only)
AK-112-C0	ASTM A479-316 SS w/No Bolts
2-3/4" Bolts listed below are for Non-Manifold Side with Rosemount 3051 or 2024 w/Coplanar Flange Transmitters	
AK-112-C0-WD	ASTM A479-316 SS w/CS Bolts
AK-112-C0-WD-W9	ASTM A479-316 SS w/316 SS Bolts
1-1/2" Bolts listed below are for Non-Manifold Side with Traditional Flange Transmitters	
AK-112-C0-WB	ASTM A479-316 SS w/CS Bolts
AK-112-C0-WB-W9	ASTM A479-316 SS w/316 SS Bolts

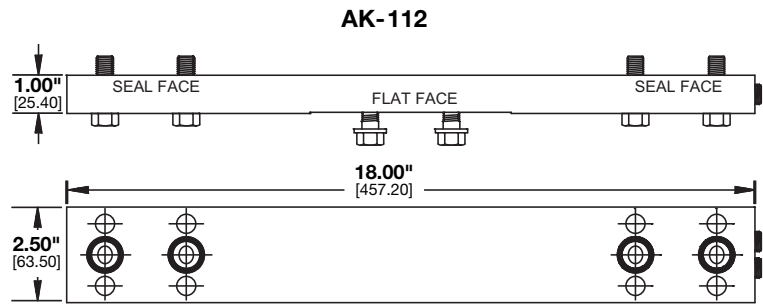

Co-Equal adapter mounts parallel to pipeline
 Dual ΔP, dual custody or bi-directional applications

• **ΔP to ΔP Adapter Plate (Standard)** 10 lbs.

PART NUMBER	MATERIAL
AK-054-10	ASTM A108-1215 CS/No Bolts
AK-054-C0	ASTM A479-316 SS/No Bolts
2-3/4" Bolts listed below are for Non-Manifold Side with Rosemount 3051 or 2024 w/Coplanar Flange Transmitters	
AK-054-10-WD	ASTM A108-1215 CS w/CS Bolts
AK-054-C0-WD	ASTM A479-316 SS w/CS Bolts
AK-054-C0-WD-W9	ASTM A479-316 SS w/316 SS Bolts
1-1/2" Bolts listed below are for Non-Manifold Side with Traditional Flange Transmitters	
AK-054-10-WB	ASTM A108-1215 CS w/CS Bolts
AK-054-C0-WB	ASTM A479-316 SS w/CS Bolts
AK-054-C0-WB-W9	ASTM A479-316 SS w/316 SS Bolts

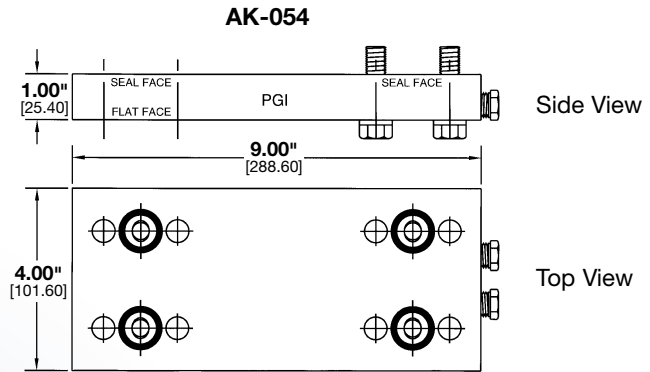

• **ΔP to ΔP Stack Adapter** 5.41 lbs.

PART NUMBER	MATERIAL
AK-036-10	ASTM A108-1215 CS w/CS Bolts
AK-036-C0	ASTM A479-316 SS w/CS Bolts
AK-036-C0-W9	ASTM A479-316 SS w/316 SS Bolts

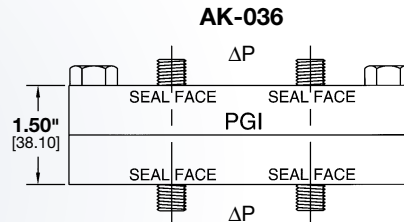

• **ΔP to ΔP Extended Length Adapter** 4 lbs.

PART NUMBER	MATERIAL
AK-074-10	ASTM A108-1215 CS w/CS Bolts
AK-074-C0	ASTM A479-316 SS w/CS Bolts

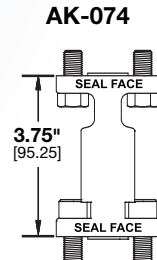

• **ΔP to Static Stack Adapter** 5.50 lbs.

PART NUMBER	MATERIAL
AK-023-10	ASTM A108-1215 CS w/CS Bolts
AK-023-C0	ASTM A479-316 SS w/CS Bolts
AK-023-C0-W9	ASTM A479-316 SS w/316 SS Bolts

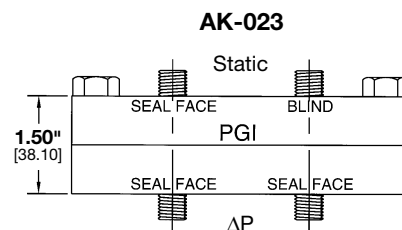

• **NOTE:** Teflon® Flange Seals Standard.
 Add "MH" for Viton® O-Ring Seals.